

Product Summary

Part Number	$V_{(BR)DSS}$ Min (V)	$r_{DS(on)}$ Max (Ω)	$V_{GS(th)}$ (V)	I_D (A)
2N7000	60	5 @ $V_{GS} = 10$ V	0.8 to 3	0.2
2N7002		7.5 @ $V_{GS} = 10$ V	1 to 2.5	0.115
VQ1000J		5.5 @ $V_{GS} = 10$ V	0.8 to 2.5	0.225
VQ1000P		5.5 @ $V_{GS} = 10$ V	0.8 to 2.5	0.225
BS170		5 @ $V_{GS} = 10$ V	0.8 to 3	0.5

Features

- Low On-Resistance: 2.5 Ω
- Low Threshold: 2.1 V
- Low Input Capacitance: 22 pF
- Fast Switching Speed: 7 ns
- Low Input and Output Leakage

Benefits

- Low Offset Voltage
- Low-Voltage Operation
- Easily Driven Without Buffer
- High-Speed Circuits
- Low Error Voltage

Applications

- Direct Logic-Level Interface: TTL/CMOS
- Drivers: Relays, Solenoids, Lamps, Hammers, Displays, Memories, Transistors, etc.
- Battery Operated Systems
- Solid-State Relays

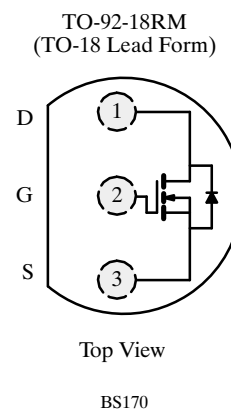
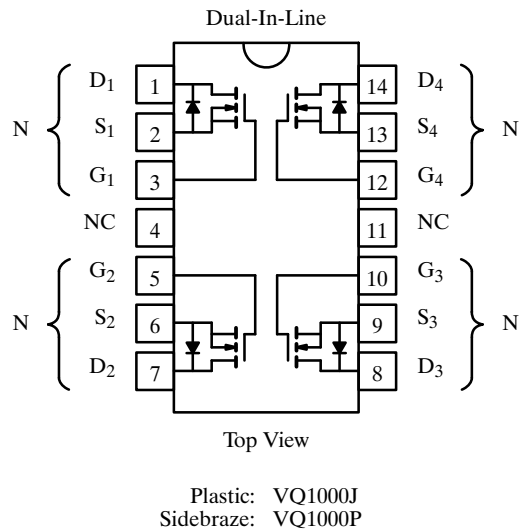
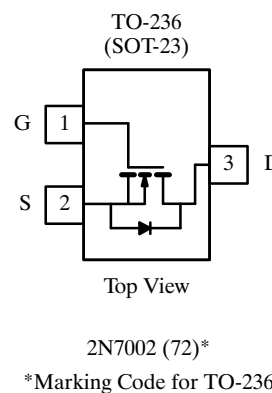
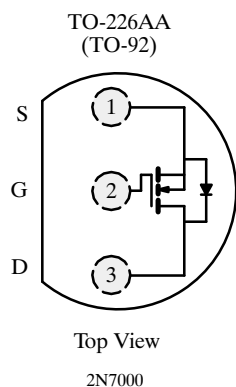

2N7000/7002, VQ1000J/P, BS170

Absolute Maximum Ratings ($T_A = 25^\circ\text{C}$ Unless Otherwise Noted)

Parameter	Symbol	2N7000	2N7002	Single		Total Quad	BS170	Unit	
				VQ1000J	VQ1000P	VQ1000J/P			
Drain-Source Voltage	V_{DS}	60	60	60	60		60	V	
Gate-Source Voltage	V_{GS}	± 40	± 40	± 30	± 20		± 25		
Continuous Drain Current ($T_J = 150^\circ\text{C}$)	$T_A = 25^\circ\text{C}$	I_D	0.2	0.115	0.225	0.225		0.5	A
	$T_A = 100^\circ\text{C}$		0.13	0.73	0.14	0.14		0.175	
Pulsed Drain Current ^a	I_{DM}	0.5	0.8	1	1				
Power Dissipation	$T_A = 25^\circ\text{C}$	P_D	0.4	0.2	1.3	1.3	2	0.83	W
	$T_A = 100^\circ\text{C}$		0.16	0.08	0.52	0.52	0.8		
Maximum Junction-to-Ambient	R_{thJA}	312.5	625	96	96	62.5	156	$^\circ\text{C}/\text{W}$	
Operating Junction and Storage Temperature Range	T_J, T_{stg}	-55 to 150						$^\circ\text{C}$	

Notes

a. Pulse width limited by maximum junction temperature.

Specifications^a for 2N7000 and 2N7002

Parameter	Symbol	Test Conditions	Typ ^b	Limits				Unit
				2N7000		2N7002		
				Min	Max	Min	Max	
Static								
Drain-Source Breakdown Voltage	$V_{(BR)DSS}$	$V_{GS} = 0\text{ V}, I_D = 10\ \mu\text{A}$	70	60		60		V
Gate-Threshold Voltage	$V_{GS(th)}$	$V_{DS} = V_{GS}, I_D = 1\text{ mA}$	2.1	0.8	3			V
		$V_{DS} = V_{GS}, I_D = 0.25\text{ mA}$	2.0			1	2.5	
Gate-Body Leakage	I_{GSS}	$V_{DS} = 0\text{ V}, V_{GS} = \pm 15\text{ V}$			± 10			nA
		$V_{DS} = 0\text{ V}, V_{GS} = \pm 20\text{ V}$					± 100	
Zero Gate Voltage Drain Current	I_{DSS}	$V_{DS} = 48\text{ V}, V_{GS} = 0\text{ V}$			1			μA
		$T_C = 125^\circ\text{C}$			1000			
		$V_{DS} = 60\text{ V}, V_{GS} = 0\text{ V}$					1	
On-State Drain Current ^c	$I_{D(on)}$	$V_{DS} = 10\text{ V}, V_{GS} = 4.5\text{ V}$	0.35	$0.07/5$				A
		$V_{DS} = 7.5\text{ V}, V_{GS} = 10\text{ V}$	1			0.5		
		$T_C = 125^\circ\text{C}$					500	
Drain-Source On-Resistance ^c	$r_{DS(on)}$	$V_{GS} = 4.5\text{ V}, I_D = 0.075\text{ A}$	4.5		5.3			Ω
		$V_{GS} = 5\text{ V}, I_D = 0.05\text{ A}$	3.2				7.5	
		$T_C = 125^\circ\text{C}$	5.8				13.5	
		$V_{GS} = 10\text{ V}, I_D = 0.5\text{ A}$	2.4		5		7.5	
Forward Transconductance ^c	g_{fs}	$T_J = 125^\circ\text{C}$	4.4		9		13.5	mS
Common Source Output Conductance ^c	g_{os}	$V_{DS} = 10\text{ V}, I_D = 0.2\text{ A}$		100		80		mS
		$V_{DS} = 5\text{ V}, I_D = 0.05\text{ A}$	0.5					

Specifications^a for 2N7000 and 2N7002

Parameter	Symbol	Test Conditions	Typ ^b	Limits				Unit
				2N7000		2N7002		
				Min	Max	Min	Max	
Dynamic								
Input Capacitance	C_{iss}	$V_{DS} = 25\text{ V}, V_{GS} = 0\text{ V}$ $f = 1\text{ MHz}$	22		60		50	pF
Output Capacitance	C_{oss}		11		25		25	
Reverse Transfer Capacitance	C_{rss}		2		5		5	
Switching^e								
Turn-On Time	t_{ON}	$V_{DD} = 15\text{ V}, R_L = 25\ \Omega$ $I_D \cong 0.5\text{ A}, V_{GEN} = 10\text{ V}$ $R_G = 25\ \Omega$	7		10			ns
Turn-Off Time	t_{OFF}		7		10			
Turn-On Time	t_{ON}	$V_{DD} = 30\text{ V}, R_L = 150\ \Omega$ $I_D \cong 0.2\text{ A}, V_{GEN} = 10\text{ V}$ $R_G = 25\ \Omega$	7				20	
Turn-Off Time	t_{OFF}		11				20	

Notes

- $T_A = 25^\circ\text{C}$ unless otherwise noted.d.
- For DESIGN AID ONLY, not subject to production testing.
- Pulse test: $PW \leq 80\ \mu\text{s}$ duty cycle $\leq 1\%$.
- This parameter not registered with JEDEC.
- Switching time is essentially independent of operating temperature.

VNBF06

Specifications^a for VQ1000J/P and BS170

Parameter	Symbol	Test Conditions	Typ ^b	Limits				Unit
				VQ1000J/P		BS170		
				Min	Max	Min	Max	
Static								
Drain-Source Breakdown Voltage	$V_{(BR)DSS}$	$V_{GS} = 0\text{ V}, I_D = 100\ \mu\text{A}$	70	60		60		V
Gate-Threshold Voltage	$V_{GS(th)}$	$V_{DS} = V_{GS}, I_D = 1\text{ mA}$	2.1	0.8	2.5	0.8	3	
Gate-Body Leakage	I_{GSS}	$V_{DS} = 0\text{ V}, V_{GS} = \pm 10\text{ V}$ $T_J = 125^\circ\text{C}$			± 100			nA
							± 10	
Zero Gate Voltage Drain Current	I_{DSS}	$V_{DS} = 25\text{ V}, V_{GS} = 0\text{ V}$					0.5	μA
		$V_{DS} = 48\text{ V}, V_{GS} = 0\text{ V}, T_J = 125^\circ\text{C}$			500			
		$V_{DS} = 60\text{ V}, V_{GS} = 0\text{ V}$			10			
On-State Drain Current ^c	$I_{D(on)}$	$V_{DS} = 10\text{ V}, V_{GS} = 10\text{ V}$	1	0.5				A
Drain-Source On-Resistance ^c	$r_{DS(on)}$	$V_{GS} = 5\text{ V}, I_D = 0.2\text{ A}$	4		7.5			Ω
		$V_{GS} = 10\text{ V}, I_D = 0.2\text{ A}$	2.3				5	
		$V_{GS} = 10\text{ V}, I_D = 0.3\text{ A}$	2.3		5.5			
		$T_J = 125^\circ\text{C}$	4.2		7.6			
Forward Transconductance ^c	g_{fs}	$V_{DS} = 10\text{ V}, I_D = 0.2\text{ A}$				100		mS
		$V_{DS} = 10\text{ V}, I_D = 0.5\text{ A}$		100				
Common Source Output Conductance ^c	g_{os}	$V_{DS} = 5\text{ V}, I_D = 0.05\text{ A}$	0.5					

2N7000/7002, VQ1000J/P, BS170

Specifications^a for VQ1000J/P and BS170

Parameter	Symbol	Test Conditions	Typ ^b	Limits				Unit
				VQ1000J/P		BS170		
				Min	Max	Min	Max	
Dynamic								
Input Capacitance	C_{iss}	$V_{DS} = 25\text{ V}, V_{GS} = 0\text{ V}$ $f = 1\text{ MHz}$	22		60		60	pF
Output Capacitance	C_{oss}		11		25			
Reverse Transfer Capacitance	C_{rss}		2		5			
Switching^d								
Turn-On Time	t_{ON}	$V_{DD} = 15\text{ V}, R_L = 23\ \Omega$ $I_D \cong 0.6\text{ A}, V_{GEN} = 10\text{ V}$ $R_G = 25\ \Omega$	7		10			ns
Turn-Off Time	t_{OFF}		7		10			
Turn-On Time	t_{ON}	$V_{DD} = 25\text{ V}, R_L = 125\ \Omega$ $I_D \cong 0.2\text{ A}, V_{GEN} = 10\text{ V}$ $R_G = 25\ \Omega$	7				10	
Turn-Off Time	t_{OFF}		7				10	

Notes

- $T_A = 25^\circ\text{C}$ unless otherwise noted.
- For DESIGN AID ONLY, not subject to production testing.
- Pulse test: $PW \leq 80\ \mu\text{s}$ duty cycle $\leq 1\%$.
- Switching time is essentially independent of operating temperature.

VNBF06

Typical Characteristics (25°C Unless Otherwise Noted)

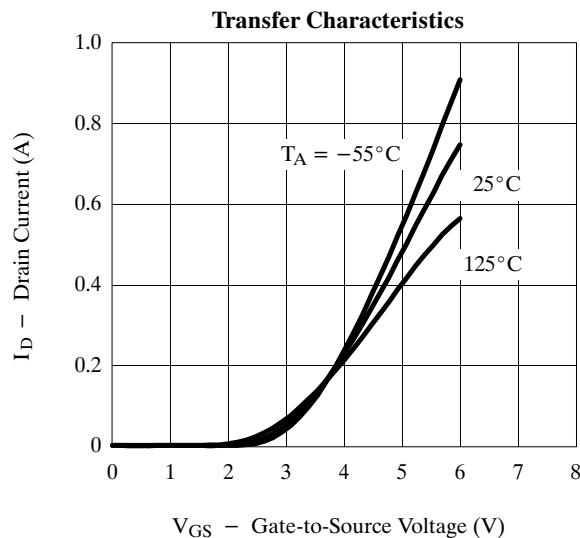
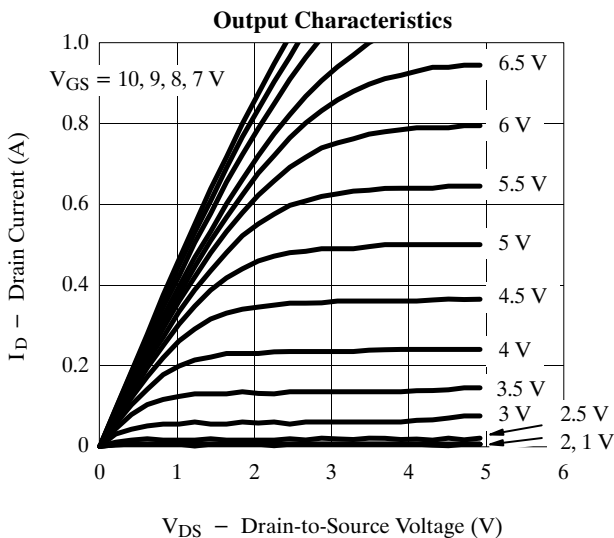

Typical Characteristics (25°C Unless Otherwise Noted)

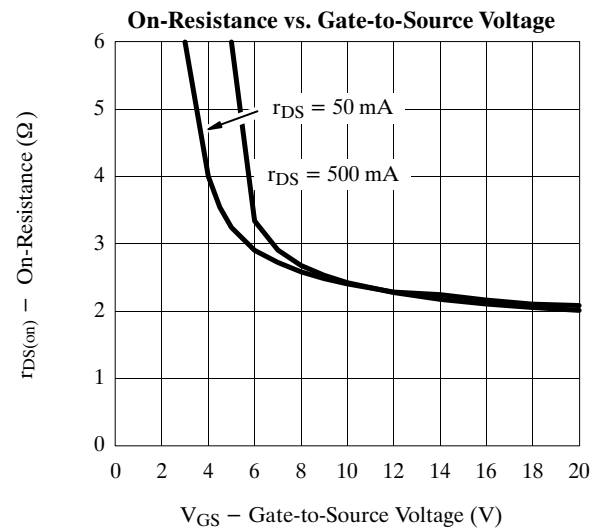
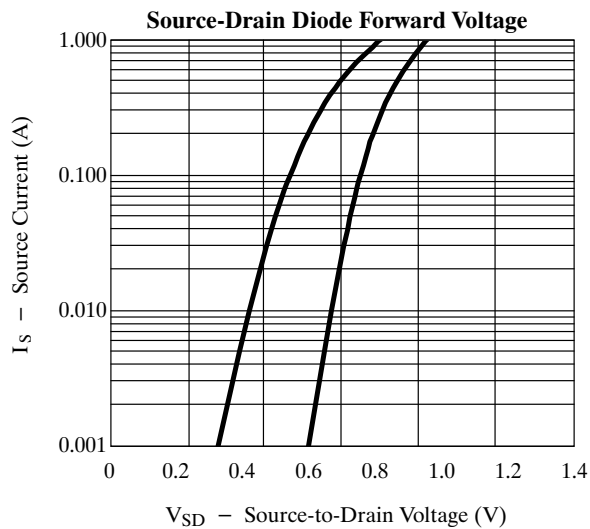
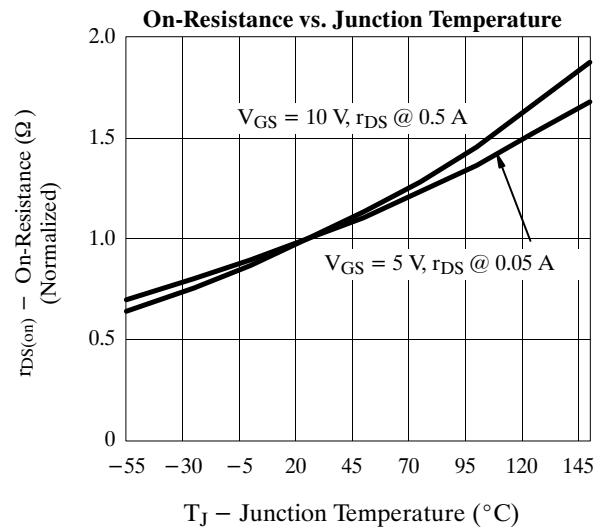
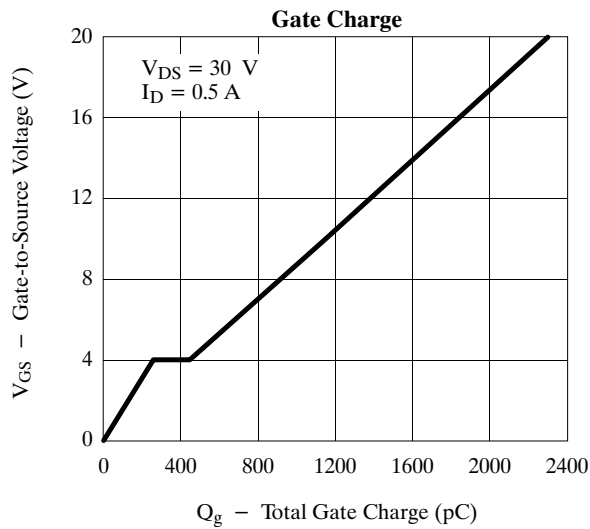
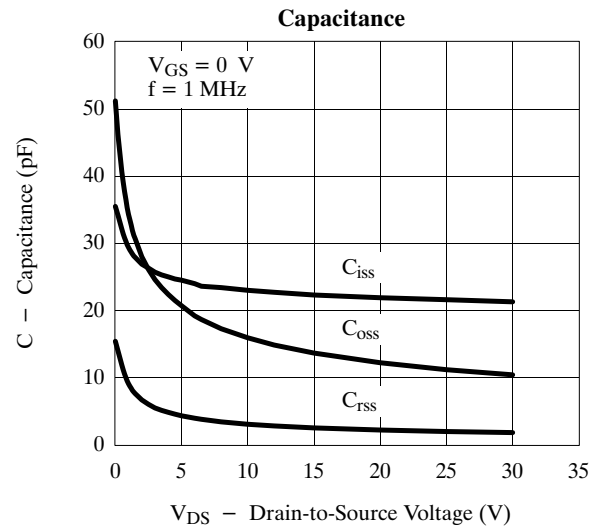
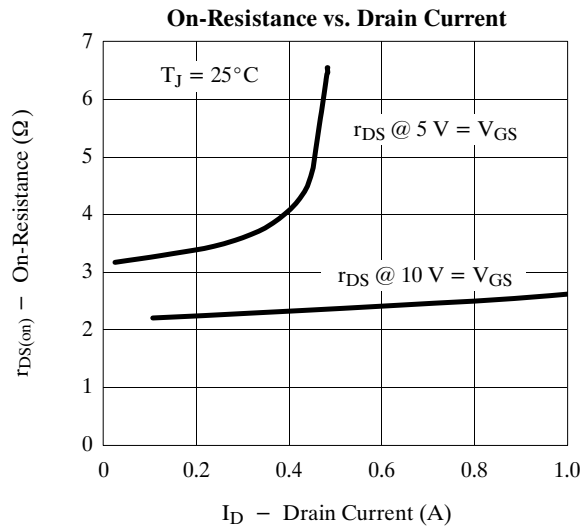

2N7000/7002, VQ1000J/P, BS170

Typical Characteristics (25°C Unless Otherwise Noted)

